

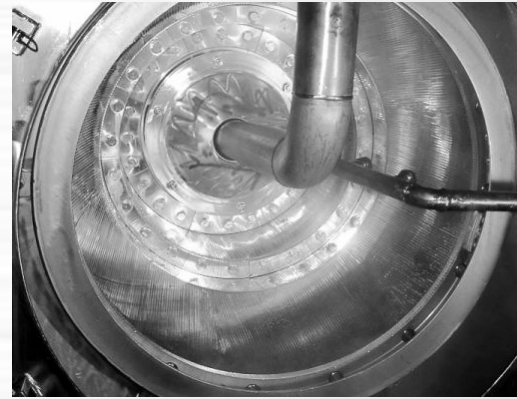

万博丝网

矿筛网



筛篮

矿筛网 筛篮

筛篮

筛缝 (S)

筛条与筛条之间的距离

筛条

常规为三角丝

支撑条

常规为三角丝，圆丝、扁带、楔形丝亦可使用

支撑条间距 (P)

支撑条与支撑条之间的距离

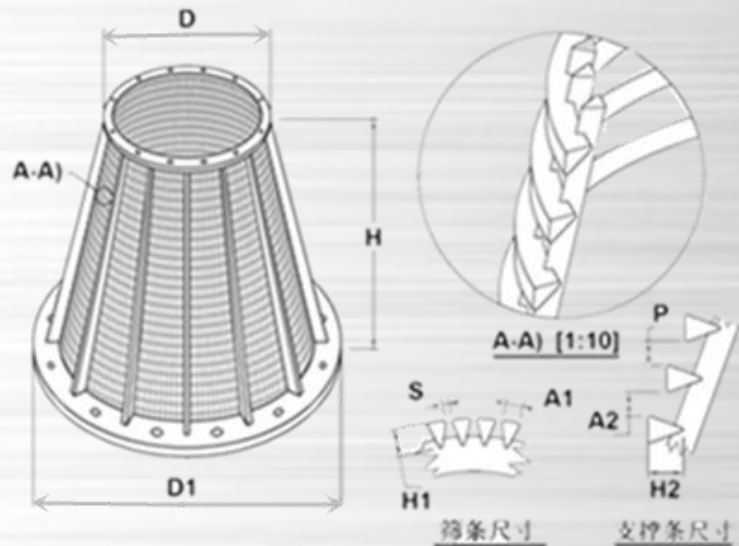

筛条/支撑条

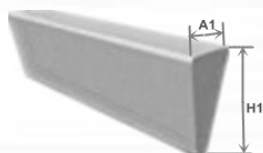

三角丝



圆丝



扁带

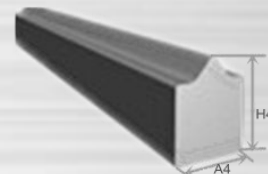

楔形丝





筛篮

外型尺寸

| 直径 D1(mm) | 高度 H(mm) | 直径 D1(mm) | 高度 H(mm) |
|-----------|-------------------------|-----------|-------------------------|
| 500 | 300, 400, 500, 600, 800 | 1200 | 300, 400, 500, 600, 800 |
| 600 | | 1300 | |
| 800 | | 1530 | |
| 1000 | | *** | |

筛篮

筛缝/筛条/支撑条

| 筛缝 S (mm) | 筛条 (mm) | | 支撑条 (mm) | | |
|--------------|---|--|---|---|---|
| | 三角丝 A1xH1 | 三角丝 A2xH2 | 圆丝 D | 扁带 A3xH3 | 楔形丝 A4xH4 |
| 0.3 |  | 1.5*4, 2.2*3.5, 2.2*4.5, 2.8*5 |  |  |  |
| 0.4 | | 2.2*3.5, 2.2*4.5, 2.8*5.0, 3.1*6, 2.8*6.5, 3.4*7.5 | 2, 3 | *** | *** |
| 0.5-0.7 | | 2.2*3.5, 2.2*4.5, 2.8*5.0, 3.1*6, 2.8*6.5, 3.4*7.5 | 3, 4, 5, 6, 7 | *** | *** |
| 0.8-1.0 | | 1.5*4, 1.8*3.0, 2.2*3.5, 2.2*4.5, 2.2*5, 2.3*3.8, 2.6*4.3, 2.7*4.2, 2.8*5, 2.8*6.5, 2.8*8, 2.8*10, 2.9*4.7, 3.1*6, 3.2*5.5, 3.4*7.5, 3.5*5.7, 5.0*7, 5*10, 6.8*9.4, 8.5*11.5 | 3, 4, 5, 6, 7 | 2*25, 3*25, 4*25 | 3*5, 4*6, 4*7.5 |
| | | | 4, 5, 6, 7, 8 | 2*25, 3*25, 4*25 | 3*5, 4*6, 4*7.5 |

矿筛网
筛篮



安平工厂图

总公司

万博丝网有限公司

河北省安平县丝网工业园东区纬二路 12 号

电话：0318-7568801

传真：0318-7568802

网址：www.webmeshgroup.com

分公司

万博丝网有限公司---石家庄分公司

河北省石家庄市新华区橙悦城

电话：0311-89255081

传真：0311-89255081

网址：www.webmeshgroup.com