



万博丝网

矿筛网



筛管



矿筛网 筛管

筛管

筛缝 (S)

筛条与筛条之间的距离

筛条

常规为三角丝

支撑条

常规为三角丝，圆丝、扁带、楔形丝亦可使用

支撑条间距 (P)

支撑条与支撑条之间的距离

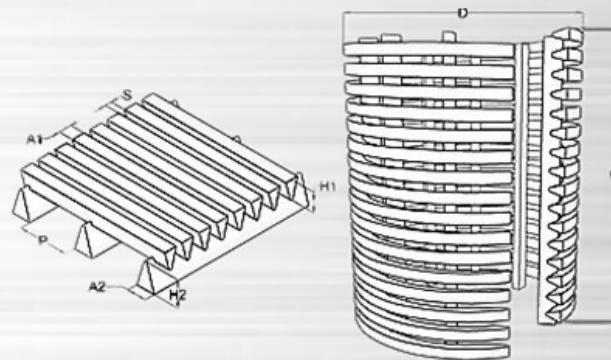

筛条/支撑条

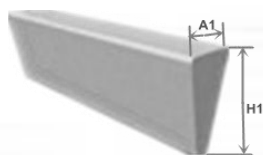

三角丝



圆丝



扁带

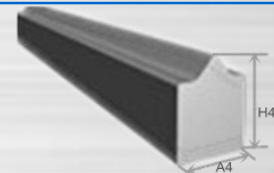

楔形丝

断头连接类型

螺纹端头

易安装拆卸，密封性好

子母扣端头

“子”指螺纹栓，“母”指螺母或螺孔



螺纹端头



子母扣端头





筛管

管径/筛缝

管径 DN(mm)	筛缝 S(mm)	管径 DN(mm)	筛缝 S(mm)	管径 DN(mm)	筛缝 S(mm)
25, 28	0.05-0.5	100, 108	0.05-2.0	600	0.05-6.0
32, 38, 40	0.05-0.8	120, 133	0.05-2.5	700	0.05-7.0
42, 45, 48	0.05-0.8	159, 196, 219	0.05-2.5	800	0.05-8.0
50, 53	0.05-1.0	240, 243, 273	0.05-2.5	900	0.05-9.0
60, 65	0.05-1.2	325, 400, 450	0.05-2.5	1000, 1100, 1200	0.05-10.0
70, 76, 89	0.05-1.5	500	0.05-5.0	1300, 1400, 1500	0.05-10.0

筛管

筛缝/筛条/支撑条

筛缝 S (mm)	筛条 (mm) 三角丝 A1xH1	支撑条 (mm)			
		管径 DN25-1500mm		管径 DN219-1500mm	
		三角丝 A2xH2	圆丝 D	扁带 A3xH3	楔形丝 A4xH4
					
0.05-0.15	0.5*1, 1*2		***	***	***
0.2-0.25	0.5*1, 1*2		2, 3	***	***
0.3	1.5*4, 2.2*3.5, 2.2*4.5, 2.8*5		2, 3	***	***
0.4	2.2*3.5, 2.2*4.5, 2.8*5.0, 3.1*6, 2.8*6.5, 3.4*7.5		3, 4, 5, 6, 7	***	***
0.5-0.7	2.2*3.5, 2.2*4.5, 2.8*5.0, 3.1*6, 2.8*6.5, 3.4*7.5		3, 4, 5, 6, 7	2*25, 3*25, 4*25	3*5, 4*6, 4*7.5
0.8-10.0	1.5*4, 1.8*3.0, 2.2*3.5, 2.2*4.5, 2.2*5, 2.3*3.8, 2.6*4.3, 2.7*4.2, 2.8*5, 2.8*6.5, 2.8*8, 2.8*10, 2.9*4.7, 3.1*6, 3.2*5.5, 3.4*7.5, 3.5*5.7, 5.0*7, 5*10, 6.8*9.4, 8.5*11.5		4, 5, 6, 7, 8	2*25, 3*25, 4*25	3*5, 4*6, 4*7.5

矿筛网

筛管



安平工厂图

总公司

万博丝网有限公司

河北省安平县丝网工业园东区纬二路 12 号

电话：0318-7568801

传真：0318-7568802

网址：www.webmeshgroup.com

分公司

万博丝网有限公司---石家庄分公司

河北省石家庄市新华区橙悦城

电话：0311-89255081

传真：0311-89255081

网址：www.webmeshgroup.com