

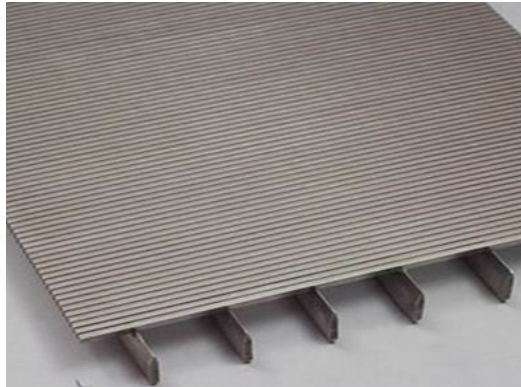

万博丝网

矿筛网



筛片

矿筛网 筛片

筛片

筛缝 (S)

筛条与筛条之间的距离

筛条

常规为三角丝

支撑条

常规为三角丝，圆丝、扁带、楔形丝亦可使用

支撑条间距 (P)

支撑条与支撑条之间的距离

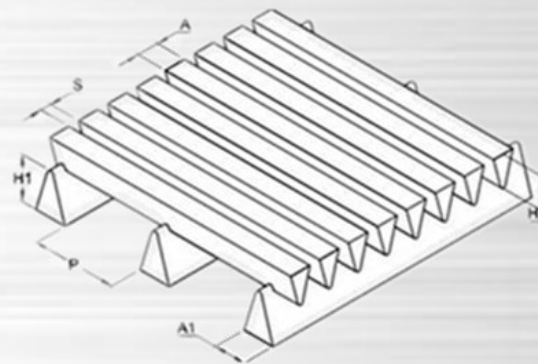

筛条/支撑条

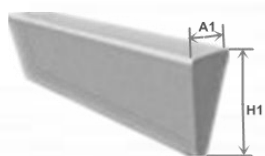

三角丝



圆丝



扁带



楔形丝

外型

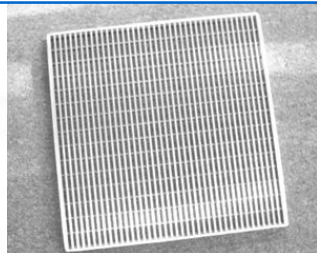

方形

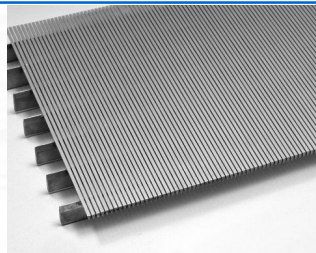

长方形

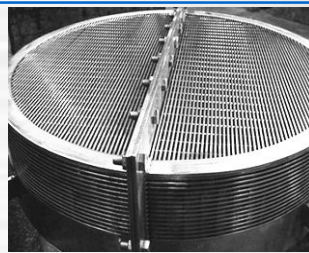

圆形

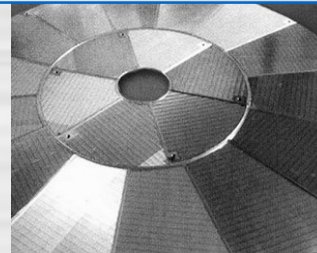

扇形

筛片 外型尺寸

	方形尺寸 L(mm)				长方形尺寸 WxL(mm)			
	50	250	700	1600	100x50	600x300	1500x400	2500x500
60	300	800	1800	200x100	800x600	1500x600	2500x1000	
80	350	900	2000	300x200	1000x400	1600x400	3000x1000	
100	400	1000	2200	400x200	1000x500	1600x600	3000x2000	
150	500	1200	2500	400x300	1200x500	2000x800	***	
200	600	1500	3000	500x300	1200x600	2000x1000	***	

筛片 筛缝/筛条/支撑条

筛缝 S (mm)	筛条 (mm)		支撑条 (mm)			
	三角丝 AxH	三角丝 A1xH1	圆丝 D	扁带 A3xH3	楔形丝 A4xH4	
						
0.05-0.15	0.5*1, 1*2		***	***	***	
0.2-0.25	0.5*1, 1*2		2, 3	***	***	
0.3	1.5*4, 2.2*3.5, 2.2*4.5, 2.8*5		2, 3	***	***	
0.4	2.2*3.5, 2.2*4.5, 2.8*5.0, 3.1*6, 2.8*6.5, 3.4*7.5		3, 4, 5, 6, 7	***	***	
0.5-0.7	2.2*3.5, 2.2*4.5, 2.8*5.0, 3.1*6, 2.8*6.5, 3.4*7.5		3, 4, 5, 6, 7	2*25, 3*25, 4*25	3*5, 4*6, 4*7.5	
0.8-10.0	1.5*4, 1.8*3.0, 2.2*3.5, 2.2*4.5, 2.2*5, 2.3*3.8, 2.6*4.3, 2.7*4.2, 2.8*5, 2.8*6.5, 2.8*8, 2.8*10, 2.9*4.7, 3.1*6, 3.2*5.5, 3.4*7.5, 3.5*5.7, 5.0*7, 5*10, 6.8*9.4, 8.5*11.5		4, 5, 6, 7, 8	2*25, 3*25, 4*25	3*5, 4*6, 4*7.5	

矿筛网 筛片



安平工厂图

总公司

万博丝网有限公司

河北省安平县丝网工业园东区纬二路 12 号

电话：0318-7568801

传真：0318-7568802

网址：www.webmeshgroup.com

分公司

万博丝网有限公司---石家庄分公司

河北省石家庄市新华区橙悦城

电话：0311-89255081

传真：0311-89255081

网址：www.webmeshgroup.com