

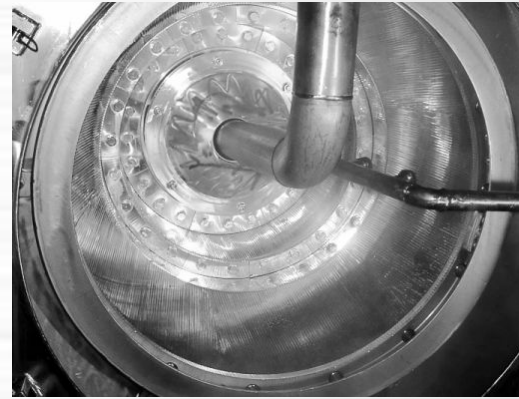

万博丝网

矿筛网



筛篮

矿筛网 筛篮

筛篮

筛缝 (S)

筛条与筛条之间的距离

筛条

常规为三角丝

支撑条

常规为三角丝，圆丝、扁带、楔形丝亦可使用

支撑条间距 (P)

支撑条与支撑条之间的距离

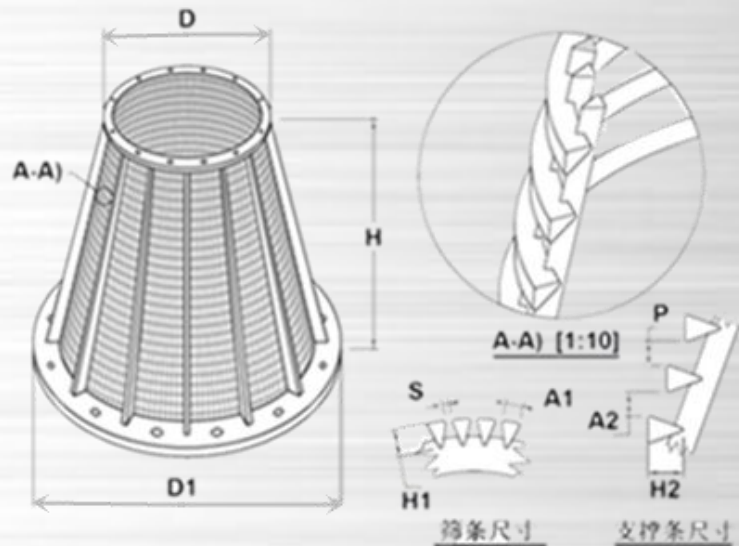

筛条/支撑条

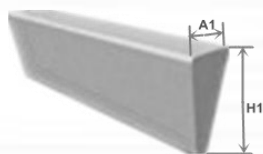

三角丝



圆丝



扁带

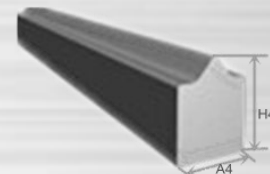

楔形丝



筛篮

外型尺寸

直径 D1(mm)	高度 H(mm)	直径 D1(mm)	高度 H(mm)
500	300, 400, 500, 600, 800	1200	300, 400, 500, 600, 800
600		1300	
800		1530	
1000		***	

筛篮

筛缝/筛条/支撑条

筛缝 S (mm)	筛条 (mm)		支撑条 (mm)		
	三角丝 A1xH1	三角丝 A2xH2	圆丝 D	扁带 A3xH3	楔形丝 A4xH4
0.3					
					
	1.5*4, 2.2*3.5, 2.2*4.5, 2.8*5		2, 3	***	***
0.4	2.2*3.5, 2.2*4.5, 2.8*5.0, 3.1*6, 2.8*6.5, 3.4*7.5		3, 4, 5, 6, 7	***	***
0.5-0.7	2.2*3.5, 2.2*4.5, 2.8*5.0, 3.1*6, 2.8*6.5, 3.4*7.5		3, 4, 5, 6, 7	2*25, 3*25, 4*25	3*5, 4*6, 4*7.5
0.8-1.0	1.5*4, 1.8*3.0, 2.2*3.5, 2.2*4.5, 2.2*5, 2.3*3.8, 2.6*4.3, 2.7*4.2, 2.8*5, 2.8*6.5, 2.8*8, 2.8*10, 2.9*4.7, 3.1*6, 3.2*5.5, 3.4*7.5, 3.5*5.7, 5.0*7, 5*10, 6.8*9.4, 8.5*11.5		4, 5, 6, 7, 8	2*25, 3*25, 4*25	3*5, 4*6, 4*7.5

矿筛网
筛篮



安平工厂图

总公司

万博丝网有限公司

河北省安平县丝网工业园东区纬二路 12 号

电话：0318-7568801

传真：0318-7568802

网址：www.webmeshgroup.com

分公司

万博丝网有限公司---石家庄分公司

河北省石家庄市新华区橙悦城

电话：0311-89255081

传真：0311-89255081

网址：www.webmeshgroup.com